

# system boyen

PLUS OŚWIETLENIE ZEWNĘTRZNE OUTDOOR LIGHTING



Uw dealer:



**ES-SYSTEM**

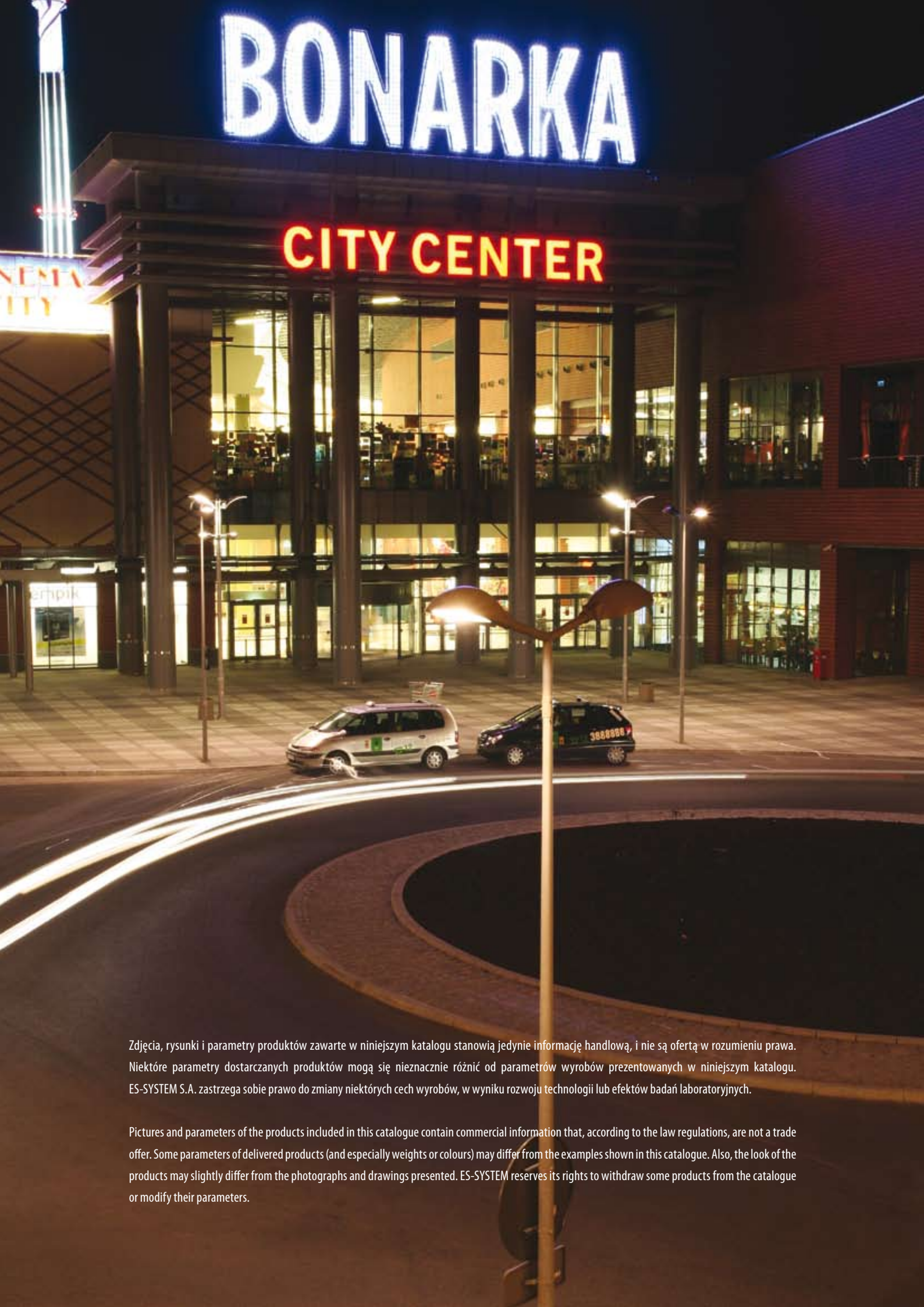

Zdjęcia, rysunki i parametry produktów zawarte w niniejszym katalogu stanowią jedynie informację handlową, i nie są ofertą w rozumieniu prawa. Niektóre parametry dostarczanych produktów mogą się nieznacznie różnić od parametrów wyrobów prezentowanych w niniejszym katalogu. ES-SYSTEM S.A. zastrzega sobie prawo do zmiany niektórych cech wyrobów, w wyniku rozwoju technologii lub efektów badań laboratoryjnych.

Pictures and parameters of the products included in this catalogue contain commercial information that, according to the law regulations, are not a trade offer. Some parameters of delivered products (and especially weights or colours) may differ from the examples shown in this catalogue. Also, the look of the products may slightly differ from the photographs and drawings presented. ES-SYSTEM reserves its rights to withdraw some products from the catalogue or modify their parameters.

# system boyen

boyen 1	boyen maxi1	8-9
boyen 2	boyen maxi2	10-11
boyen 3	boyen maxi3	12-13
boyen 4	boyen maxi4	14-15
boyen 5	boyen maxi5	16-17
boyen 6	boyen maxi6	18-19
boyen 8	boyen maxi7	20-23

OUTDOOR LIGHTING  
oświetlenie

# zewnętrzne

system SL	26-28
system WSL	29
system OCP	30-37
system ALBATROS	38-40





# SYSTEM boyen

Street lighting designers, with a help of the most advanced computer software, easily find variants for optimal lighting points location and light beam directions to conform with the road illumination standards.

The actual installation usually requires numerous corrections to the virtually planned solutions. Especially in urban environment where lighting poles are often obstructed by trees, banners, electric traction supports or other elements of urban architecture. Execution of idealist plans in such sophisticated conditions is not always possible.

The team of product designers from ES-SYSTEM presents a new system of street lighting luminaires, BOYEN, offering many options that allow to achieve optimal lighting effect in various conditions. Due to a unique multistage regulation of the light output and pivot joint for adjusting the fitting's inclination angle, BOYEN ensures best effects – even in case of necessary pole relocation, comparing to the original plans.

Very simple installation makes the BOYEN fittings user-friendly and easy for maintenance. Combination of simplicity, functionality and mature constructional solutions applied in the BOYEN family, resulted with recognition of experts from the Association of Polish Electricians for the range.

During the International Power Industry Exhibition „ENERGETAB 2008” in Bielsko-Biała, our BOYEN was awarded the Gold Medal.



Projektanci oświetlenia drogowego, posługujący się nowoczesnymi programami komputerowymi oraz normami oświetleniowymi, przygotowują w swoich projektach optymalne warianty umiejscowienia punktów świetlnych oraz ukierunkowania rozsyłu światła.

Kiedy dochodzi do rzeczywistej realizacji projektu pojawiają się nieraz okoliczności wymagające korekt w stosunku do zaplanowanych wirtualnie rozwiązań. Ma to najczęściej miejsce podczas modernizacji oświetlenia dróg, gdzie nowe oprawy instalowane są na istniejących słupach i wysięgnikach. W takich warunkach uzyskanie założonych efektów nie zawsze jest możliwe.

Zespół konstruktorów ES-SYSTEM opracował nowy system opraw ulicznych BOYEN, który ma bardzo szerokie możliwości optymalizacji efektu świetlnego w różnych warunkach. Oprawy tego systemu, poza możliwością płynnej regulacji kąta zawieszenia opraw, pozwalają użytkownikowi na optymalizację krzywej rozsyłu w zależności od konkretnej sytuacji na drodze.

Prostota i łatwość montażu powodują, że oprawy systemu BOYEN stają się przyjazne nie tylko dla użytkownika, ale i dla konserwatora serwisującego oświetlenie.

Połączenie prostoty i funkcjonalności z zaawansowanymi rozwiązaniami konstrukcyjnymi, sprawiły że system BOYEN spotkał się z pozytywną oceną ekspertów ze Stowarzyszenia Elektryków Polskich. Podczas Targów ENERGETAB 2008 w Bielsku Białej oprawa systemu BOYEN otrzymała „Złoty medal za najbardziej wyróżniający się produkt targowy”.

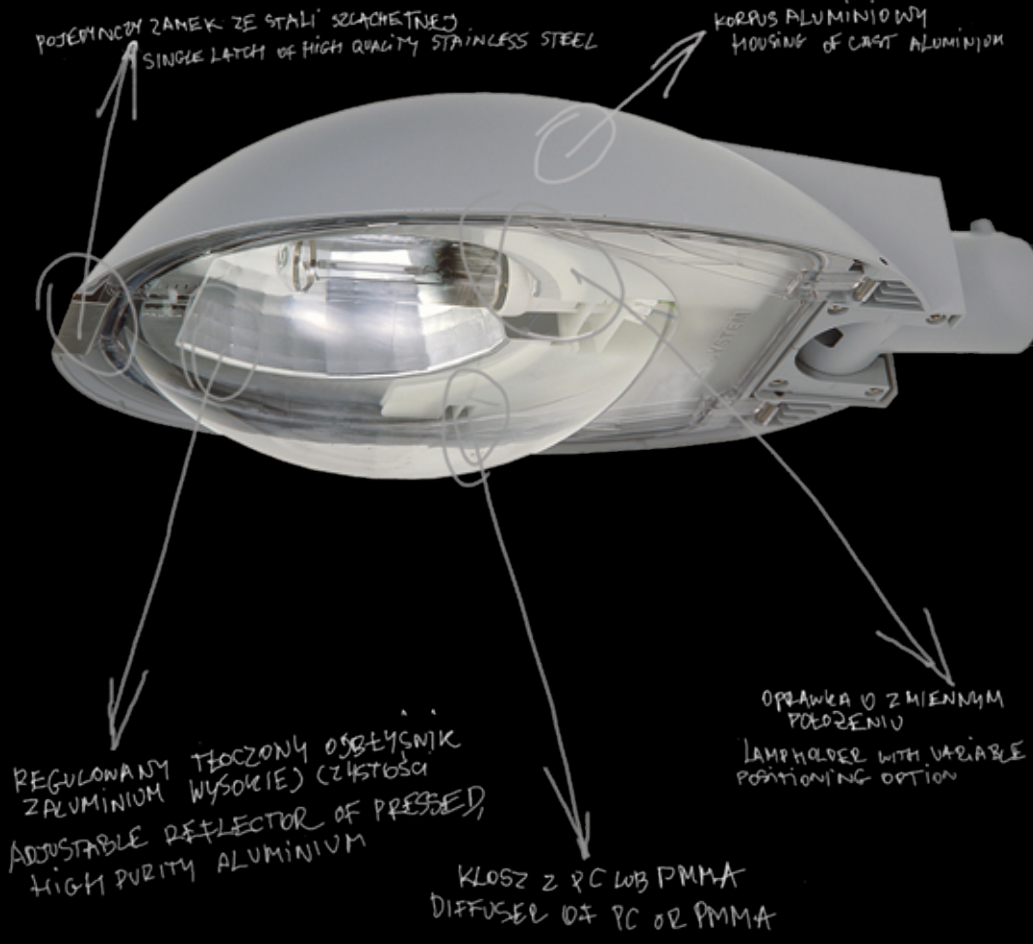

boyen 70W

oprawka / lamp holder poz. 1  
odbłyśnik / reflector poz. 3

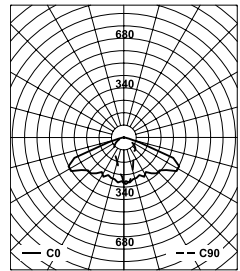

oprawka / lamp holder poz. 3  
odbłyśnik / reflector poz. 3

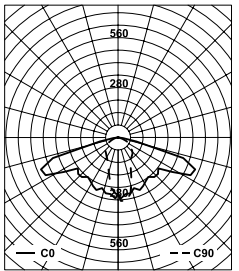

oprawka / lamp holder poz. 5  
odbłyśnik / reflector poz. 3

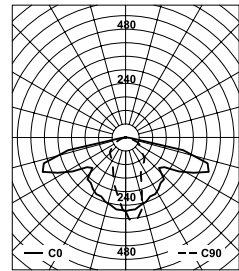

boyen maxi 100W

oprawka / lamp holder poz. 1  
odbłyśnik / reflector poz. 3

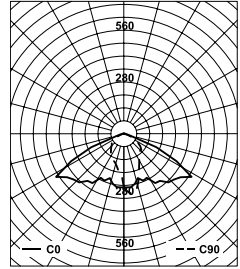

oprawka / lamp holder poz. 3  
odbłyśnik / reflector poz. 3

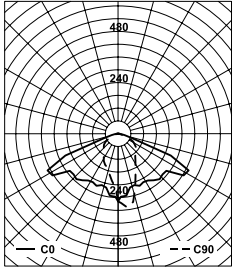

oprawka / lamp holder poz. 5  
odbłyśnik / reflector poz. 3

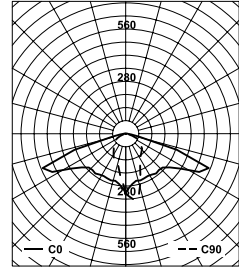



boyen maxi 150W

oprawka / lamp holder poz. 1  
odbłyśnik / reflector poz. 3

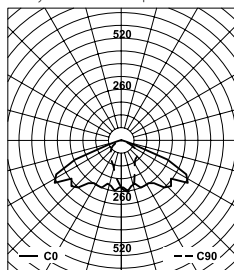

oprawka / lamp holder poz. 3  
odbłyśnik / reflector poz. 3

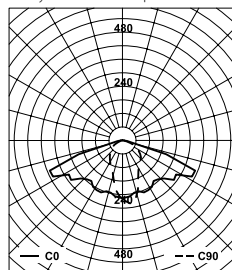

oprawka / lamp holder poz. 5  
odbłyśnik / reflector poz. 3

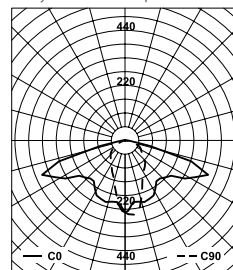

boyen maxi 250W

oprawka / lamp holder poz. 1  
odbłyśnik / reflector poz. 3

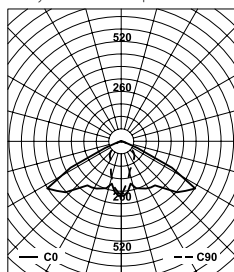

oprawka / lamp holder poz. 3  
odbłyśnik / reflector poz. 3

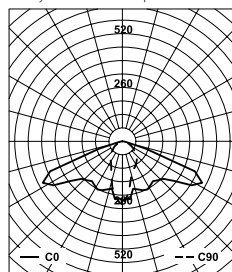

oprawka / lamp holder poz. 5  
odbłyśnik / reflector poz. 3

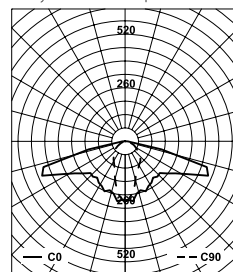

boyen LED

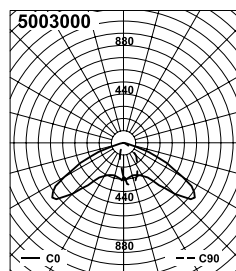



Oprawa z kloszem / Luminaire with plastic diffuser

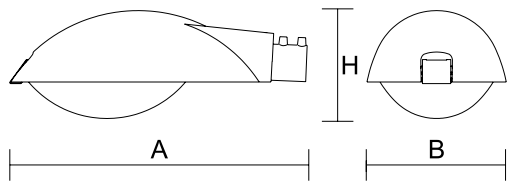

Oprawa z szybą / Luminaire with glass

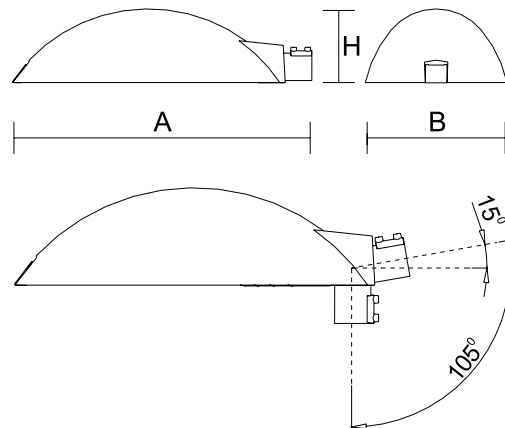

Single luminaires. Housing of cast aluminium. Diffusers of PC, PMMA or flat hardened glass. High protection against solids and liquids penetration – IP66. Adjustable inclination angle by the means of a pivot joint built in the housing. Compact construction and elegant, streamlined shape make ideal for any environment. During the design stage the strongest accent was put on the environmental protection and energy saving solutions. All fitting's components are fully recyclable. The reflector, detail crucial for the optimum photometrics, was precisely manufactured of high purity aluminium sheet to ensure lighting efficiency exceeding 82%. The user can change the lamp's lighting quality selecting from 40 options of possible reflector/lamp holder complex position. The luminaires are designed for high-pressure sodium or metal halide lamps ranging from 50W to 250W, supported by electronic or magnetic ballasts. The electrical components of the luminaires, besides a very popular autonomic power reduction system, are also suitable to cooperate with intelligent lighting control system that enables wireless control of all supervised lamps. Air circulation between the lamp chamber and surroundings is enabled by a special breather – the gland with a filter of the Gore foil that allows the air exchange but efficiently stops moisture intrusion.



Oprawa SSL (LED) / Luminaire SSL (LED)



Oprawy budowy jednokomorowej z korpusem wykonanym jako ciśnieniowy odlew aluminiowy. Klosze z tworzywa (PC lub PMMA) albo w postaci płaskiej, hartowanej szyby. Wysoki stopień ochrony (IP66) przed wnikaniem wilgoci i zanieczyszczeń. Gniazdo mocowania oprawy jest częścią korpusu i pozwala na płynną regulację kąta zawieszenia. Zwarta, kompaktowa budowa i opływowy kształt sprawiają, że oprawy doskonale komponują się z każdym otoczeniem. Na etapie konstruowania oprawy największy nacisk położono na spełnienie wymagań ekologicznych i oszczędności energii. Wszystkie elementy składowe oprawy nadają się do recyklingu. Odbłyśnik oprawy, najważniejszy detal decydujący o właściwej fotometrii, wykonano z aluminium wysokiej czystości i daje on oprawie sprawność świetlną powyżej 82%.

Użytkownik ma możliwość zmiany charakterystyki świetlnej oprawy poprzez wybór jednego z 40-tu możliwych położań podzespołu odbłyśnik – oprawka. Oprawy współpracują z lampami wysokoprężnymi, sodowymi lub metalohalogenkowymi, o mocach od 50W do 250W, zasilanymi poprzez elektroniczne lub konwencjonalne układy stabilizacyjne. Osprzęt elektryczny, poza popularnym już autonomicznym układem redukcji mocy, przystosowany został do pracy w tzw. inteligentnym systemie sterowania oświetleniem, który pozwala m.in. na bezprzewodową kontrolę stanu pracy lampy w każdej oprawie systemu.

Wymianę powietrza między komorą oprawy a otoczeniem umożliwia specjalna dławnica, z membraną z folii Gore, która pozwala na przepływ powietrza, skutecznie zatrzymując cząsteczki pary wodnej.



## boyen 1







Oprawa z kloszem / Luminaire with plastic diffuser

AxBxH

<b>3055120</b>	<b>3055120M</b>	BOY1.CRI.35	HIT-CRI 35W	G12	577x270x209	5,40
<b>3055220</b>	<b>3055220M</b>	BOY1.CRI.70	HIT-CRI 70W	G12	577x270x209	5,50
<b>3055320</b>	<b>3055320M</b>	BOY1.50	HST-MF 50W	E27	577x270x209	5,40
<b>3055420</b>	<b>3055420M</b>	BOY1.70	HST-MF 70W	E27	577x270x209	5,50
<b>3055520</b>	<b>3055520M</b>	BOY1.CPO.60	CPO-TW 60W	PGZ12	577x270x209	5,50

XXXXXX – Klosz PC / PC diffuser    XXXXXXM – Klosz PMMA / PMMA diffuser

Oprawa z szybą / Luminaire with glass

<b>3056120</b>		BOY1.S.CRI.35	HIT-CRI 35W	G12	577x270x140	6,50
<b>3056220</b>		BOY1.S.CRI.70	HIT-CRI 70W	G12	577x270x140	6,60
<b>3056320</b>		BOY1.S.50	HST-MF 50W	E27	577x270x140	6,50
<b>3056420</b>		BOY1.S.70	HST-MF 70W	E27	577x270x140	6,60
<b>3056520</b>		BOY1.S.CPO.60	CPO-TW 60W	PGZ12	577x270x140	6,60

## boyen maxi 1







Oprawa z kloszem PC / Luminaire with PC diffuser

AxBxH

<b>3057020</b>		BOYM1.100	HST 100W	E40	765x356x278	9,20
<b>3057120</b>		BOYM1.150	HST 150W	E40	765x356x278	9,30
<b>3057220</b>		BOYM1.250	HST 250W	E40	765x356x278	9,50

Oprawa z szybą / Luminaire with glass

<b>3058020</b>		BOYM1.S.100	HST 100W	E40	765x356x190	10,40
<b>3058120</b>		BOYM1.S.150	HST 150W	E40	765x356x190	10,50
<b>3058220</b>		BOYM1.S.250	HST 250W	E40	765x356x190	10,70

Korpus – odlew aluminiowy, klosz  
– tworzywo lub szyba, regulowany  
rozsył, płynna regulacja kąta zawieszenia,  
**klasa ochronności pierwsza.**

Housing of cast aluminium. Plastic diffuser  
or hardened glass. Adjustable light  
distribution. Pivot joint to adjust  
an angle of inclination. **Safety Class I.**



# X Łatwa instalacja i konserwacja

Simple installation and maintenance

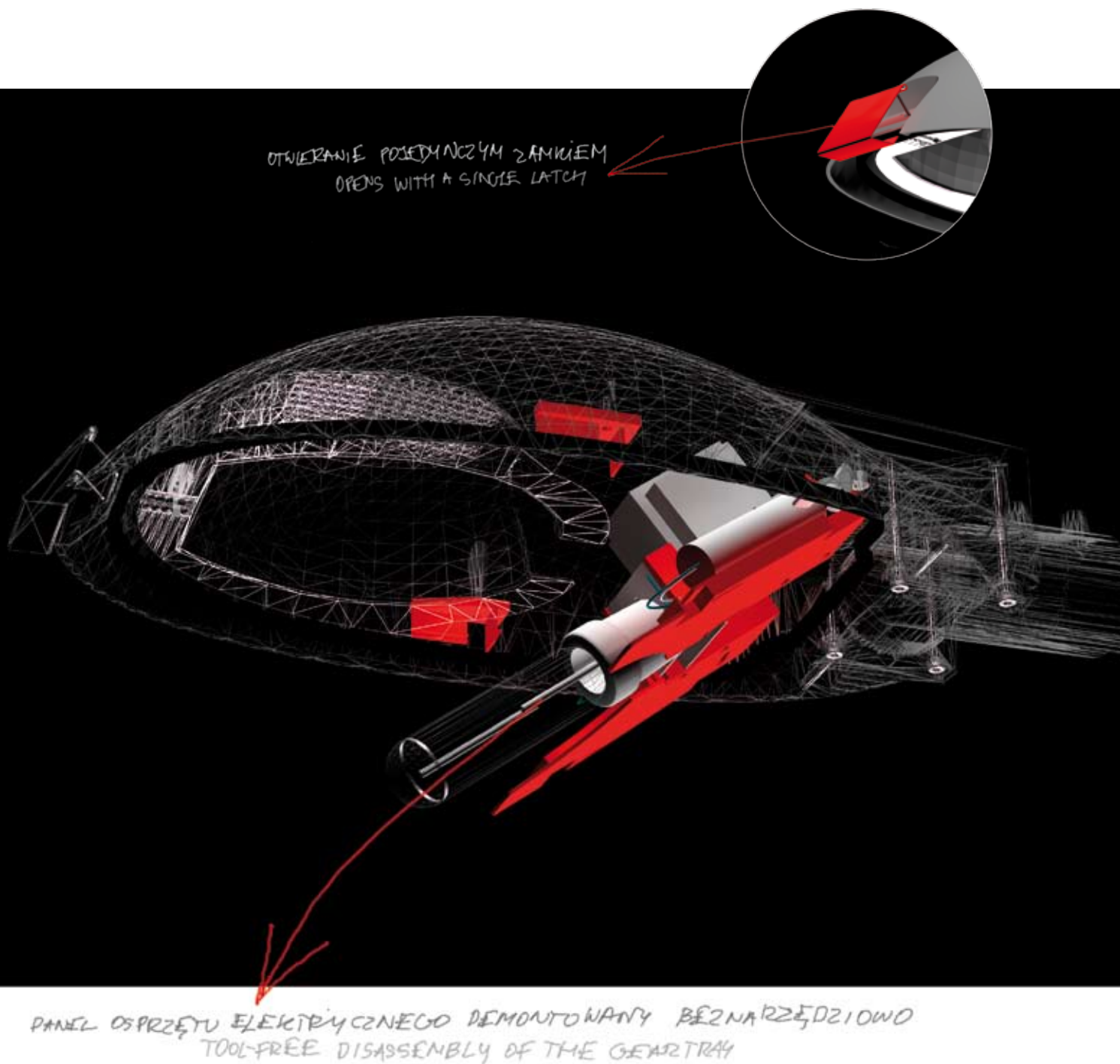

Otwieranie oprawy pojedynczym zamkiem od dołu. Osprzęt elektryczny na izolowanym panelu demontowany beznarzędziowo. Stalowa linka zabezpieczająca osprzęt. Ułatwiona konserwacja klosza. Przystosowanie do końcówek masztów  $\varnothing$  42-60 mm.

Opening by the means of a single latch. Tool-free disassembly of electrically insulated geartray protected with a safety lanyard. Simple diffuser maintenance. Suitable for  $\varnothing$  42-60 mm pole tops.



## boyen 2

Oprawa z kloszem / Luminaire with plastic diffuser

<b>3055000</b>	<b>3055000M</b>	BOY2.TC.42	TC-TEL 42W	Gx24q-4	577x270x209	5,20
<b>3055100</b>	<b>3055100M</b>	BOY2.CRI.35	HIT-CRI 35W	G12	577x270x209	5,40
<b>3055200</b>	<b>3055200M</b>	BOY2.CRI.70	HIT-CRI 70W	G12	577x270x209	5,50
<b>3055300</b>	<b>3055300M</b>	BOY2.50	HST-MF 50W	E27	577x270x209	5,40
<b>3055400</b>	<b>3055400M</b>	BOY2.70	HST-MF 70W	E27	577x270x209	5,50
<b>3055500</b>	<b>3055500M</b>	BOY2.CPO.60	CPO-TW 60W	PGZ12	577x270x209	5,50

XXXXXXX – Klosz PC / PC diffuser    XXXXXXXM – Klosz PMMA / PMMA diffuser

Oprawa z szybą / Luminaire with glass

<b>3056000</b>		BOY2.S.TC.42	TC-TEL 42W	Gx24q-4	577x270x140	6,30
<b>3056100</b>		BOY2.S.CRI.35	HIT-CRI 35W	G12	577x270x140	6,50
<b>3056200</b>		BOY2.S.CRI.70	HIT-CRI 70W	G12	577x270x140	6,60
<b>3056300</b>		BOY2.S.50	HST-MF 50W	E27	577x270x140	6,50
<b>3056400</b>		BOY2.S.70	HST-MF 70W	E27	577x270x140	6,60
<b>3056500</b>		BOY2.S.CPO.60	CPO-TW 60W	PGZ12	577x270x140	6,60

## boyen maxi 2

Oprawa z kloszem PC / Luminaire with PC diffuser

<b>3057000</b>		BOYM2.100	HST 100W	E40	765x356x278	9,20
<b>3057100</b>		BOYM2.150	HST 150W	E40	765x356x278	9,30
<b>3057200</b>		BOYM2.250	HST 250W	E40	765x356x278	9,50

Oprawa z szybą / Luminaire with glass

<b>3058000</b>		BOYM2.S.100	HST 100W	E40	765x356x190	10,40
<b>3058100</b>		BOYM2.S.150	HST 150W	E40	765x356x190	10,50
<b>3058200</b>		BOYM2.S.250	HST 250W	E40	765x356x190	10,70

Korpus – odlew aluminiowy, klosz – tworzywo lub szyba, regulowany rozsył, płynna regulacja kąta zawieszenia, klasa ochronności pierwsza, **dławnica do wymiany powietrza, linka zabezpieczająca panel z osprzętem.**

Housing of cast aluminium. Plastic diffuser or hardened glass. Adjustable light distribution. Pivot joint to adjust an angle of inclination. Safety Class I. **Air breather. Safety lanyard to the geartray.**



# X Płynna regulacja kąta nachylenia

Pivot joint to adjust the angle of inclination

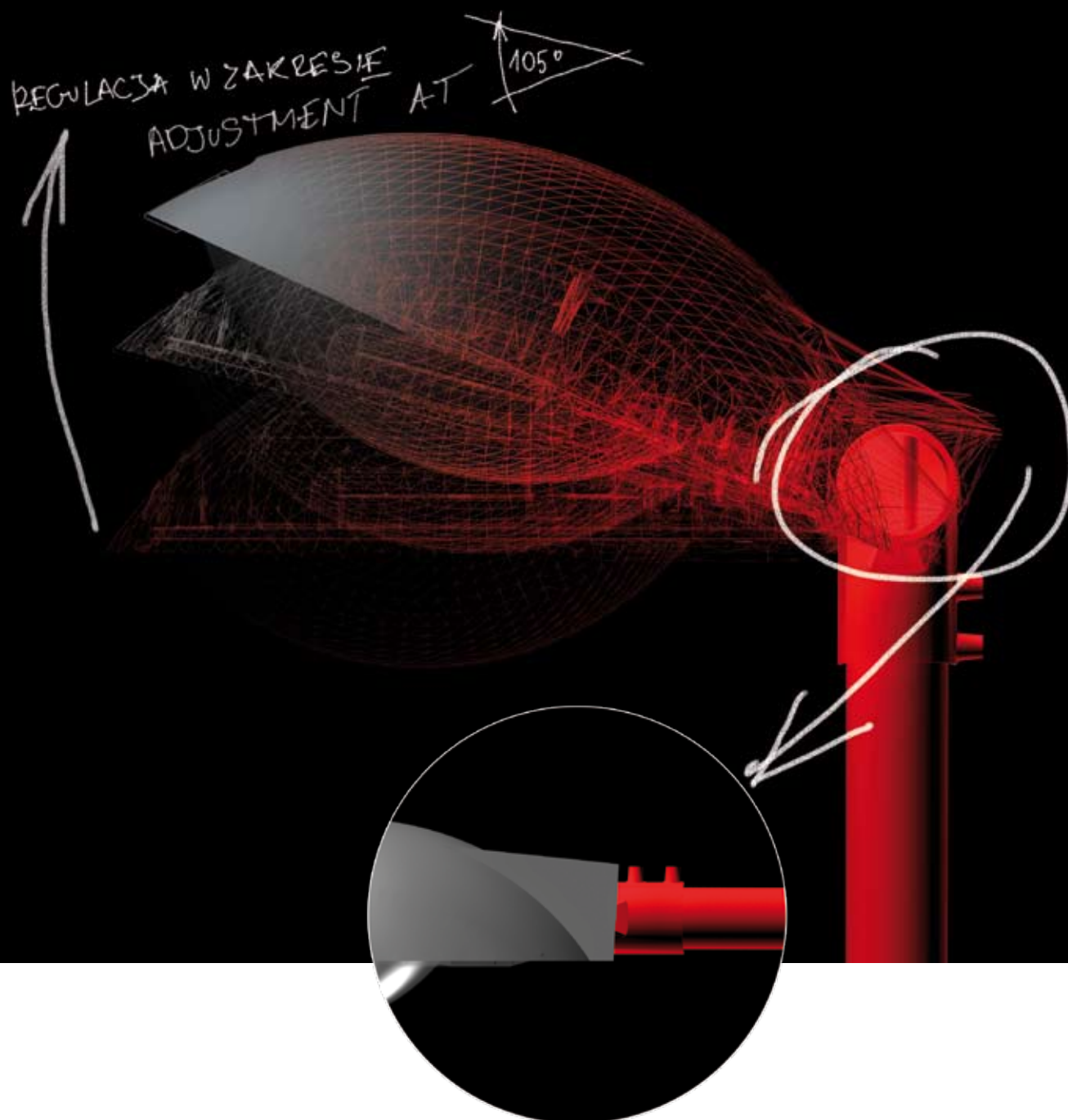

Zintegrowany z oprawą mocownik umożliwiającą płynną regulację kąta nachylenia zarówno na maszcie w pozycji pionowej, jak i na wysięgniku w pozycji poziomej, w zakresie do 105°.

Pivot joint built in the housing enables smooth adjustment of an angle of inclination up to 105 degrees: on vertical lighting poles as well as on horizontal extensions.



## boyen 3



Oprawa z kloszem / Luminaire with plastic diffuser

AxBxH

<b>3050120</b>	<b>3050120M</b>	BOY3.CRI.35	HIT-CRI 35W	G12	577x270x209	5,50
<b>3050220</b>	<b>3050220M</b>	BOY3.CRI.70	HIT-CRI 70W	G12	577x270x209	5,60
<b>3050320</b>	<b>3050320M</b>	BOY3.50	HST-MF 50W	E27	577x270x209	5,50
<b>3050420</b>	<b>3050420M</b>	BOY3.70	HST-MF 70W	E27	577x270x209	5,60
<b>3050520</b>	<b>3050520M</b>	BOY3.CPO.60	CPO-TW 60W	PGZ12	577x270x209	5,60

XXXXXXXX – Klosz PC / PC diffuser    XXXXXXXM – Klosz PMMA / PMMA diffuser

Oprawa z szybą / Luminaire with glass

<b>3051120</b>		BOY3.S.CRI.35	HIT-CRI 35W	G12	577x270x140	6,60
<b>3051220</b>		BOY3.S.CRI.70	HIT-CRI 70W	G12	577x270x140	6,70
<b>3051320</b>		BOY3.S.50	HST-MF 50W	E27	577x270x140	6,60
<b>3051420</b>		BOY3.S.70	HST-MF 70W	E27	577x270x140	6,70
<b>3051520</b>		BOY3.S.CPO.60	CPO-TW 60W	PGZ12	577x270x140	6,70

## boyen maxi 3

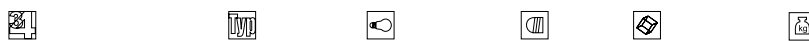

Oprawa z kloszem PC / Luminaire with PC diffuser

AxBxH

<b>3052020</b>		BOYM3.100	HST 100W	E40	765x356x278	9,30
<b>3052120</b>		BOYM3.150	HST 150W	E40	765x356x278	9,40
<b>3052220</b>		BOYM3.250	HST 250W	E40	765x356x278	9,60

Oprawa z szybą / Luminaire with glass

<b>3053020</b>		BOYM3.S.100	HST 100W	E40	765x356x190	10,50
<b>3053120</b>		BOYM3.S.150	HST 150W	E40	765x356x190	10,60
<b>3053220</b>		BOYM3.S.250	HST 250W	E40	765x356x190	10,80

Korpus – odlew aluminium, klosz – tworzywo lub szyba, regulowany rozsył, płynna regulacja kąta zawieszenia, **klasa ochronności druga**, linka zabezpieczająca panel z osprzętem.

Housing of cast aluminium. Plastic diffuser or hardened glass. Adjustable light distribution. Pivot joint to adjust an angle of inclination. **Safety Class II**. Safety lanyard to the geartray.



# X Doskonała charakterystyka optyczna

Excellent optical characteristics



Wysokowydajny jednoczęściowy odbłyśnik wykonany z aluminium wysokiej czystości, wybluszczany i zabezpieczony galwanicznie. Regulacja rozsyłu strumienia oprawy poprzez zmianę położenia odbłyśnika w 5 pozycjach oraz zmianę położenia oprawki w 8 pozycjach.

High-efficiency, one-piece reflector made of high-purity, electro polished aluminium. Galvanic protection. Light distribution adjustment by a change of the reflector position (5 options) or the lamp holder position (8 options).



## boyen 4







Oprawa z kloszem / Luminaire with plastic diffuser

AxBxH

<b>3050000</b>	<b>3050000M</b>	BOY4.TC.42	TC-TEL 42W	Gx24q-4	577x270x209	5,30
<b>3050100</b>	<b>3050100M</b>	BOY4.CRI.35	HIT-CRI 35W	G12	577x270x209	5,50
<b>3050200</b>	<b>3050200M</b>	BOY4.CRI.70	HIT-CRI 70W	G12	577x270x209	5,60
<b>3050300</b>	<b>3050300M</b>	BOY4.50	HST-MF 50W	E27	577x270x209	5,50
<b>3050400</b>	<b>3050400M</b>	BOY4.70	HST-MF 70W	E27	577x270x209	5,60
<b>3050500</b>	<b>3050500M</b>	BOY4.CPO.60	CPO-TW 60W	PGZ12	577x270x209	5,60

XXXXXXX – Klosz PC / PC diffuser    XXXXXXXM – Klosz PMMA / PMMA diffuser

Oprawa z szybą / Luminaire with glass

<b>3051000</b>		BOY4.S.TC.42	TC-TEL 42W	Gx24q-4	577x270x140	6,40
<b>3051100</b>		BOY4.S.CRI.35	HIT-CRI 35W	G12	577x270x140	6,60
<b>3051200</b>		BOY4.S.CRI.70	HIT-CRI 70W	G12	577x270x140	6,70
<b>3051300</b>		BOY4.S.50	HST-MF 50W	E27	577x270x140	6,60
<b>3051400</b>		BOY4.S.70	HST-MF 70W	E27	577x270x140	6,70
<b>3051500</b>		BOY4.S.CPO.60	CPO-TW 60W	PGZ12	577x270x140	6,70

## boyen maxi 4







Oprawa z kloszem PC / Luminaire with PC diffuser

AxBxH

<b>3052000</b>		BOYM4.100	HST 100W	E40	765x356x278	9,30
<b>3052100</b>		BOYM4.150	HST 150W	E40	765x356x278	9,40
<b>3052200</b>		BOYM4.250	HST 250W	E40	765x356x278	9,60

Oprawa z szybą / Luminaire with glass

<b>3053030</b>		BOYM4.S.100	HST 100W	E40	765x356x190	10,50
<b>3053130</b>		BOYM4.S.150	HST 150W	E40	765x356x190	10,60
<b>3053230</b>		BOYM4.S.250	HST 250W	E40	765x356x190	10,80

Korpus – odlew aluminiowy, klosz – tworzywo lub szyba, regulowany rozsył, płynna regulacja kąta zawieszenia, klasa ochronności druga, **dławnica do wymiany powietrza**, linka zabezpieczająca panel z osprzętem.

Housing of cast aluminium. Plastic diffuser or hardened glass. Adjustable light distribution. Pivot joint to adjust an angle of inclination. Safety Class II.

**Air breather.** Safety lanyard to the geartray.



# X Energooszczędność

Energy saving

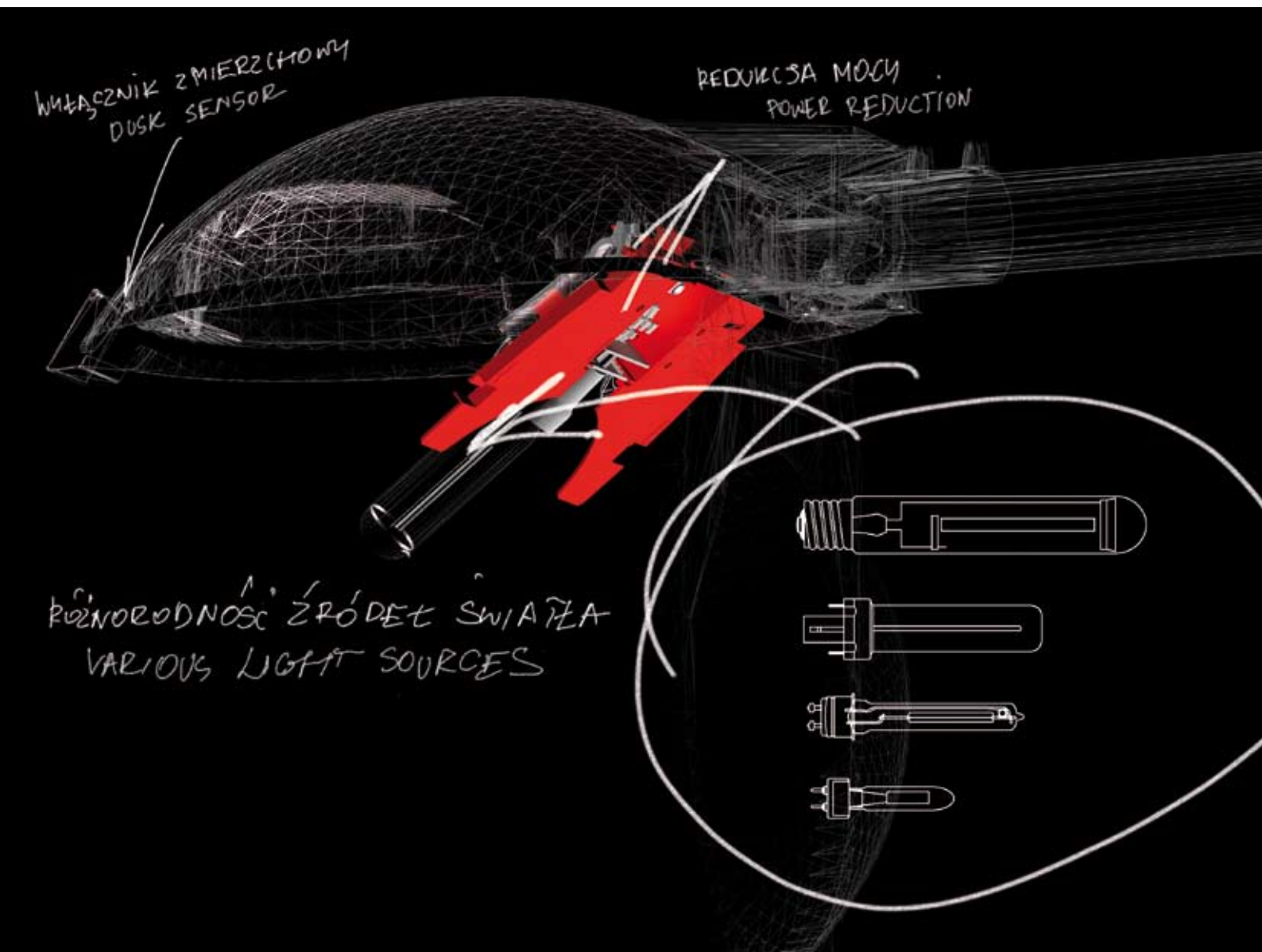

Oprawy współpracują z lampami sodowymi, metalohalogenkowymi, świetłówkowymi zasilanymi poprzez elektroniczne lub konwencjonalne układy stabilizacyjne. Opcjonalnie oprawy wyposażone są w układy redukcji mocy, w których zastosowano autonomiczny mikroprocesorowy reduktor ograniczający moc pobieraną przez oprawę w zaprogramowanym przedziale czasowym. Opcjonalnie oprawy wyposażone w wyłącznik zmierzchowy.

The luminaires are designed for high-pressure sodium or metal halide lamps supported by electronic or magnetic ballasts. Upon request, luminaires can be supplied with power reduction devices equipped with an autonomic, microprocessor limiter that reduces power consumption and luminous flux in a default time interval. Dusk sensor installed on request.



## boyen 5



Oprawa z kloszem / Luminaire with plastic diffuser

AxBxH

<b>3050350</b>	BOY5.WZ.50	HST-MF 50W	E27	577x270x209	5,60
<b>3050550</b>	BOY5.WZ.70	HST-MF 70W	E27	577x270x209	5,70

XXXXXXX – Klosz PC / PC diffuser    XXXXXXXM – Klosz PMMA / PMMA diffuser

Oprawa z szybą / Luminaire with glass

<b>3051350</b>	BOY5.S.WZ.50	HST-MF 50W	E27	577x270x140	6,70
<b>3051450</b>	BOY5.S.WZ.70	HST-MF 70W	E27	577x270x140	6,80

## boyen maxi 5



Oprawa z kloszem PC / Luminaire with PC diffuser

AxBxH

<b>3052050</b>	BOYM5.WZ.100	HST 100W	E40	765x356x278	9,40
<b>3052150</b>	BOYM5.WZ.150	HST 150W	E40	765x356x278	9,50
<b>3052250</b>	BOYM5.WZ.250	HST 250W	E40	765x356x278	9,70

Oprawa z szybą / Luminaire with glass

<b>3053050</b>	BOYM5.S.WZ.100	HST 100W	E40	765x356x190	10,60
<b>3053150</b>	BOYM5.S.WZ.150	HST 150W	E40	765x356x190	10,70
<b>3053250</b>	BOYM5.S.WZ.250	HST 250W	E40	765x356x190	10,90

Korpus – odlew aluminiowy, klosz – tworzywo lub szyba, regulowany rozsył, płynna regulacja kąta zawieszenia, klasa ochronności druga, dławnica do wymiany powietrza, linka zabezpieczająca panel z osprzętem, **sterowanie wyłącznikiem zmierzchowym.**

Housing of cast aluminium. Plastic diffuser or hardened glass. Adjustable light distribution. Pivot joint to adjust an angle of inclination. Safety Class II. Air breather. Safety lanyard to the geartray. **Dusk sensor.**



# X Nowoczesna i trwała konstrukcja

Innovative and durable construction

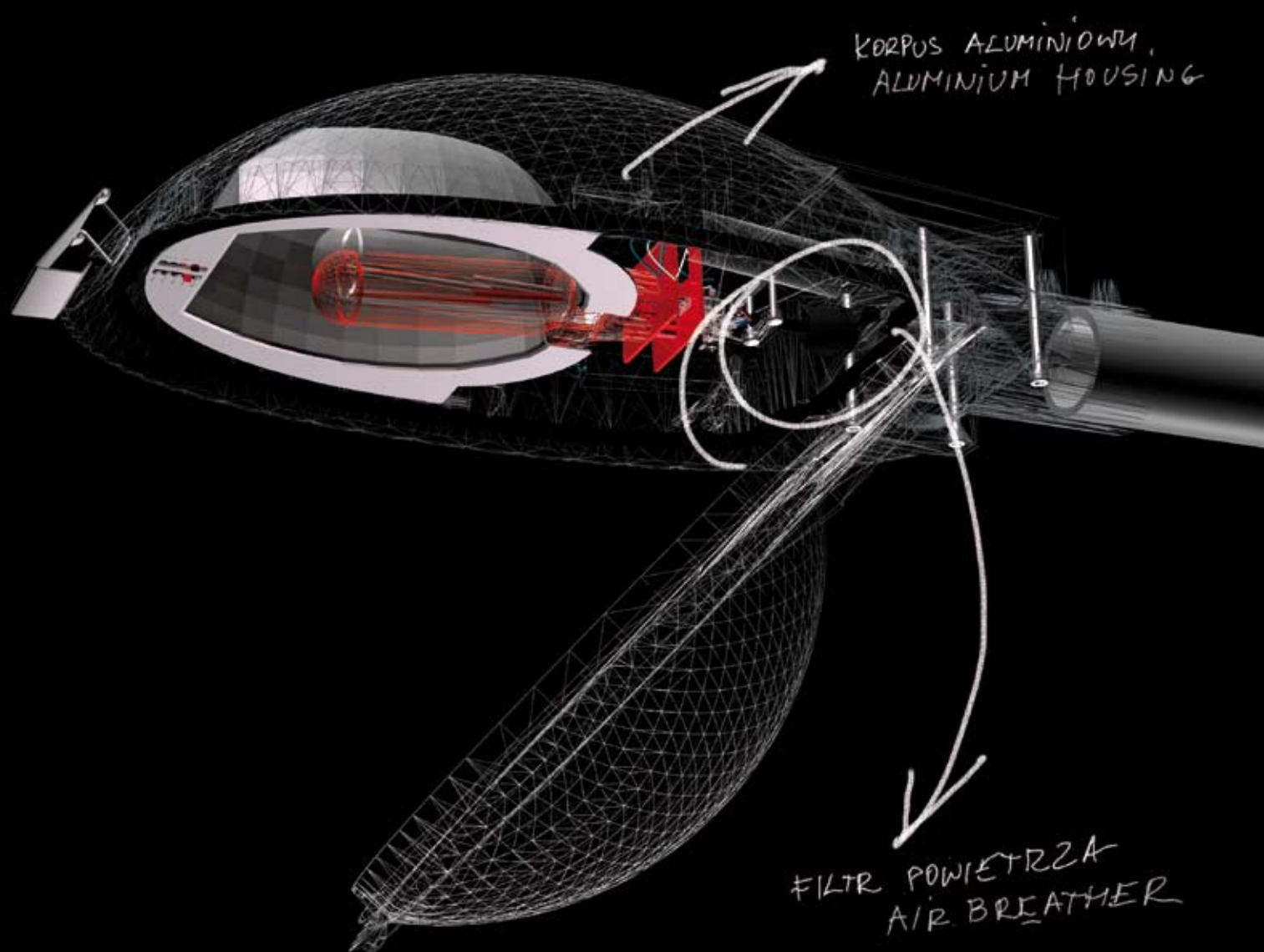

Korpus oprawy wykonany jako odlew aluminium. Klosz PC odporny na UV lub szyba hartowana. IP66: wysoki stopień ochrony przed wnikaniem wilgoci i zanieczyszczeń. Filtr umożliwiający wymianę powietrza z otoczeniem.

Housing of cast aluminium. UV stabilized plastic diffuser or hardened glass. IP66: high protection against moisture and dust penetration. Air filter to ensure air circulation.



## boyen 6



Oprawa z kloszem / Luminaire with plastic diffuser

AxBxH

<b>3050410</b>	<b>3050410M</b>	BOY6.RM.70/50	HST-MF 70W	E27	577x270x209	5,70
----------------	-----------------	---------------	------------	-----	-------------	------

XXXXXXXX – Klosz PC / PC diffuser    XXXXXXXM – Klosz PMMA / PMMA diffuser

Oprawa z szybą / Luminaire with glass

<b>3051410</b>		BOY6.S.RM.70/50	HST-MF 70W	E27	577x270x140	6,80
----------------	--	-----------------	------------	-----	-------------	------

## boyen maxi 6



Oprawa z kloszem PC / Luminaire with PC diffuser

AxBxH

<b>3052040</b>		BOYM6.RM.100/70	HST 100W	E40	765x356x278	9,50
<b>3052140</b>		BOYM6.RM.150/100	HST 150W	E40	765x356x278	9,60
<b>3052240</b>		BOYM6.RM.250/150	HST 250W	E40	765x356x278	9,80

Oprawa z szybą / Luminaire with glass

<b>3053040</b>		BOYM6.S.RM.100/70	HST 100W	E40	765x356x190	10,70
<b>3053140</b>		BOYM6.S.RM.150/100	HST 150W	E40	765x356x190	10,80
<b>3053240</b>		BOYM6.S.RM.250/150	HST 250W	E40	765x356x190	11,00

Korpus – odlew aluminiowy, klosz– tworzywo lub szyba, regulowany rozsył, płynna regulacja kąta zawieszenia, klasa ochronności druga, dławnica do wymiany powietrza, linka zabezpieczająca panel z osprzętem, **układ redukcji mocy.**

Housing of cast aluminium. Plastic diffuser or hardened glass. Adjustable light distribution. Pivot joint to adjust an angle of inclination. Safety Class II. Air breather. Safety lanyard to the geartray. **Power reduction system.**



# X Minimalne ośnienie

Minimal glare

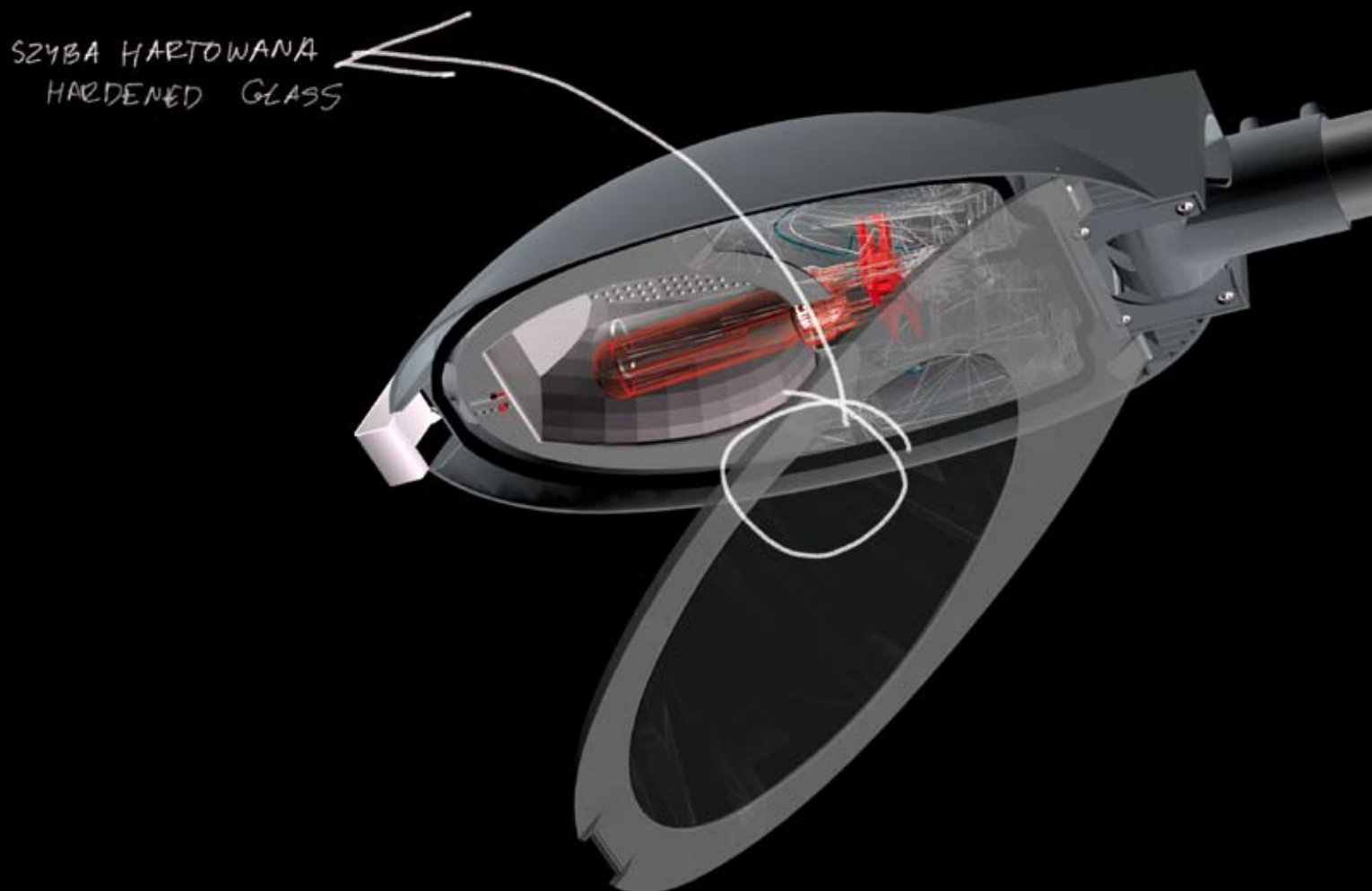

Klosz wykonany z płaskiej szyby hartowanej eliminującej zjawiska ośnienia. W wersji BOYEN MAXI dodatkowo ramka aluminiowa.

Diffuser made of a flat hardened glass for glare reduction. Version Maxi with framed glass diffuser.



## boyen maxi 7



Oprawa z szybą / Luminaire with glass

AxBxH

3054030	BOYM7.S.150/150AW	2xHST 150W	E40	765x356x190	12,00
---------	-------------------	------------	-----	-------------	-------

Korpus – odlew aluminiowy, klosz – szyba, regulowany rozsył, płynna regulacja kąta zawieszenia, klasa ochronności druga, dławnica do wymiany powietrza, linka zabezpieczająca panel z osprzętem, **wersja dwuźródłowa.**

Housing of cast aluminium. Diffuser of hardened glass. Adjustable light distribution. Pivot joint to adjust an angle of inclination. Safety Class II. Air breather. Safety lanyard to the geartray. **Two lamps.**



# X Wersja dwuźródłowa

Version with two lamps

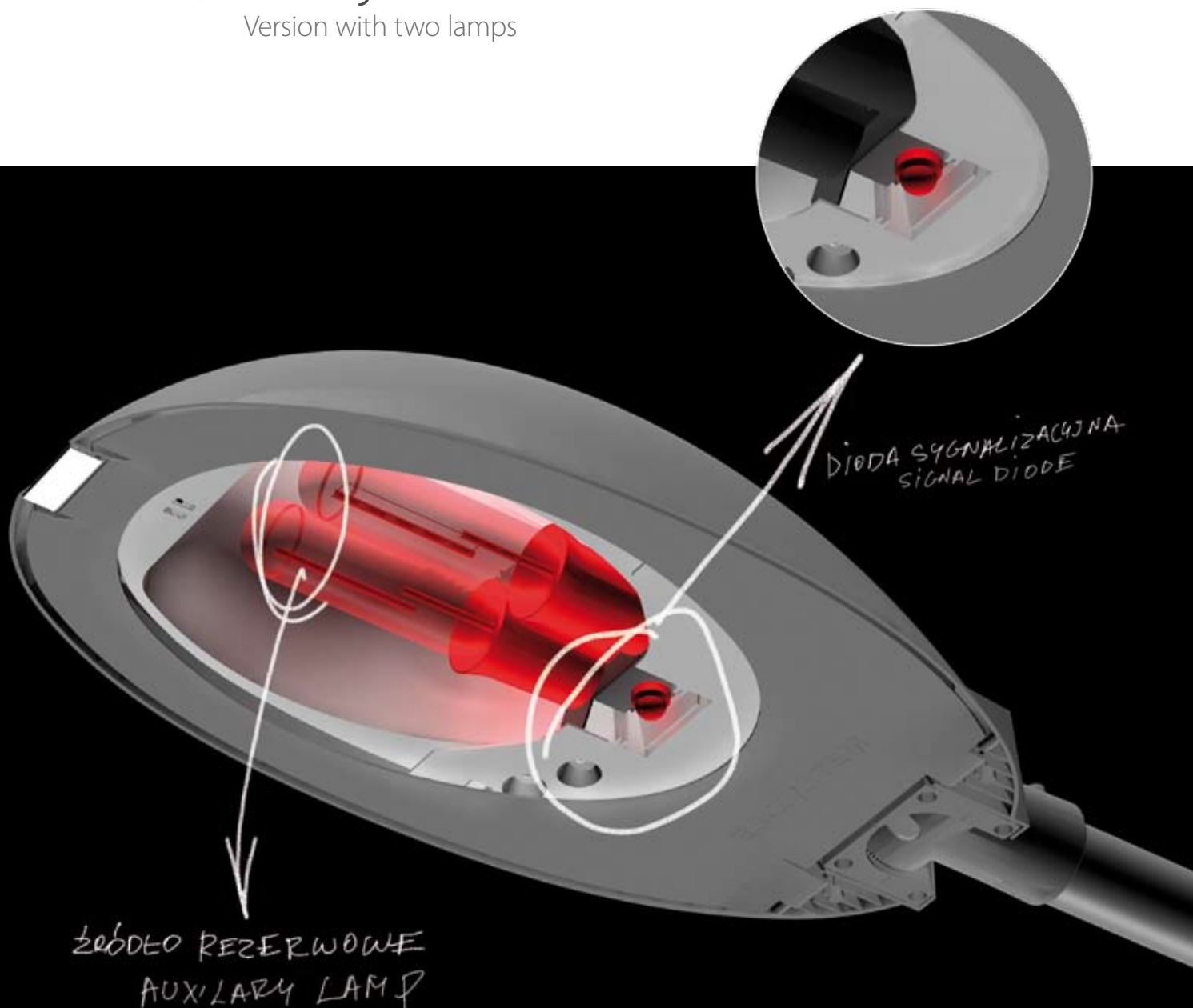





Oprawa dwuźródłowa. Drugie źródło pełni rolę awaryjną i podejmuje pracę w przypadku awarii źródła podstawowego. Wizualna sygnalizacja awarii źródła za pomocą diody barwy czerwonej.

Luminaire with two lamps. The auxiliary lamp switches automatically on at the failure of the main lamp. Visual signaling of the failure by the means of a red LED.



## boyen 8

			Lumen		
Oprawa z szybą / Luminaire with glass					
<b>50030?0</b>	BOY8.70	LED	4000 lm	577x270x140	5,30
.....?. 0 - EVG • 9 - 1-10 V					
Oprawa z szybą, z układem redukcji mocy / Luminaire with glass, power reduction system					
<b>5003100</b>	BOY8.70/30	LED	4000 / 3000 lm	577x270x140	5,30
Oprawa z szybą, sterowanie bezprzewodowe / Luminaire with glass, wireless remote control					
* <b>5003200</b>	BOY8.70	LED	4000 lm	577x270x140	5,60

\* wymaga zewnętrznych elementów sterujących, specyfikowanych oddzielnie  
remote controllers upon additional order

Korpus – odlew aluminiowy, klosz – szyba hartowana, płynna regulacja kąta zawieszenia, klasa ochronności druga, **dławnica do wymiany powietrza, diodowe źródło światła.**

Housing of cast aluminium. Diffuser of hardened glass. Pivot joint to adjust an angle of inclination. Safety Class II. **Air breather. LEDs.**



# X Wersja Boyen SSL (LED)

Version Boyen SSL (LED)

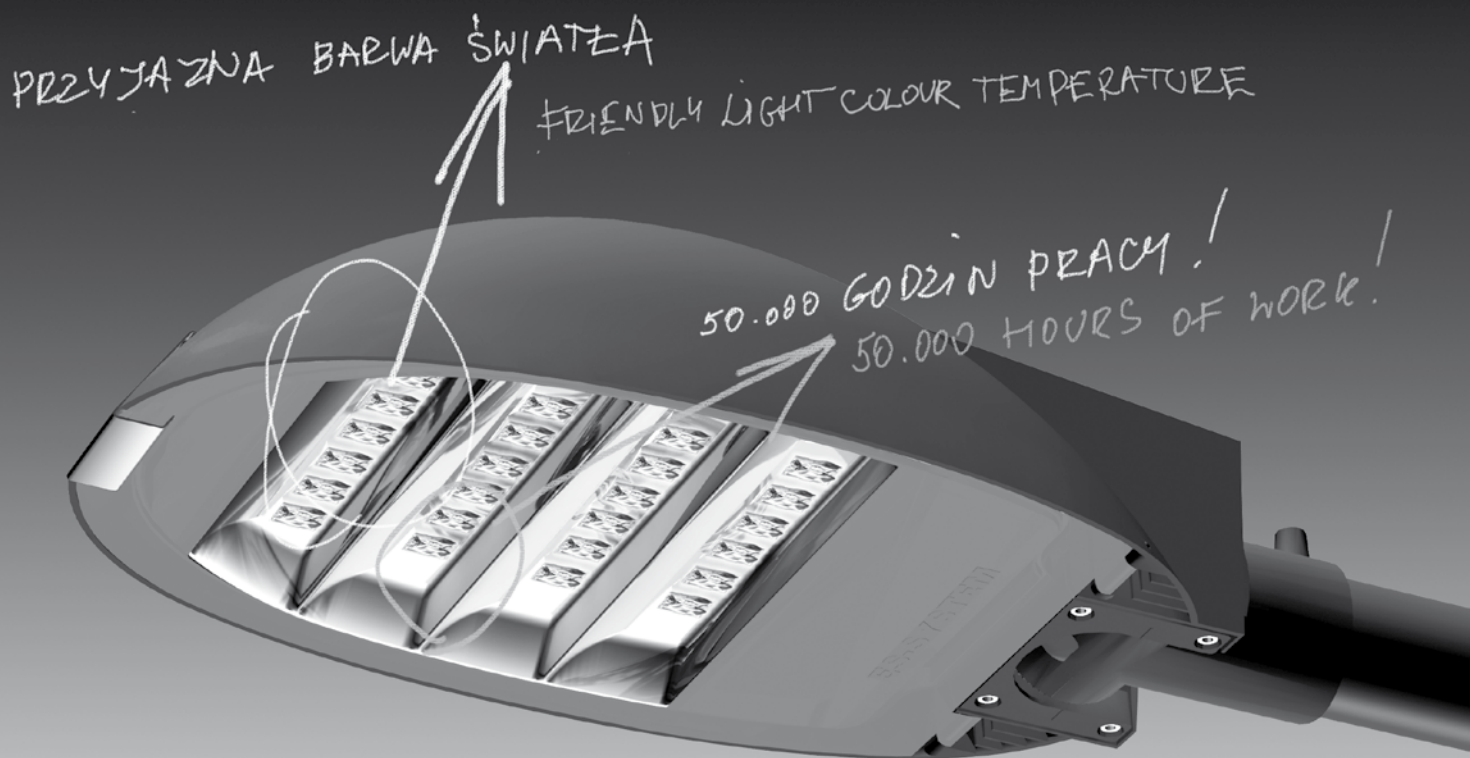

Oprawy drogowe systemu Boyen wyposażone w diodowe źródła światła (Power LED). Efektywne połączenie sprawdzonej konstrukcji opraw Boyen z nowoczesnym źródłem światła. Trwałość eksploatacyjna modułu LED to 50 tys. godzin czyli ponad 12 lat użytkowania w oświetleniu ulicznym. Typowy dla opraw drogowych rozsył światła uzyskano dzięki systemowi soczewek, umieszczonych bezpośrednio na diodach. Oprawy cechuje wysoka odporność na wibracje ze względu na zwartą budowę modułu LED. Komora lampowa zamknięta jest płaską szybą hartowaną. Barwa światła diod jest biała, szczególnie pożądana w handlowych centrach miast. Ponadto oprawy z zespołem diodowym doskonale nadają się do płynnej regulacji wielkości strumienia świetlnego. Zawarty w nazwie oprawy termin SSL (Solid-state lighting) odnosi się do urządzeń oświetleniowych, które jako źródła światła wykorzystują półprzewodnikowe diody świecące (LED), organiczne diody emitujące światło (OLED) lub polimerowe diody świecące (PLED). W grupie SSL największą popularnością cieszą się obecnie diody LED (Light Emitting Diode) o dużej mocy. Do podstawowych zalet SSL można przypisać mały pobór mocy, dużą jasność, krótki czas reakcji, małe gabaryty oraz nieszkodliwość dla środowiska.

Street lighting luminaire BOYEN with Power LEDs effectively combines verified construction of the system with the most modern light sources. The rated life of the LED module is 50K hours – this equals more than 12 years of operation! Special, typical for the roadlighting light distribution, was achieved due to carefully selected optical lenses, installed directly on the diodes. Because of a rigid construction of the LED module, the fitting is strongly resistant against vibrations. The lamp chamber is tightly closed by a hardened glass. Dimmable, cool white or warm white diodes are recommended especially for busy, commercial areas. The term SSL (Solid-state lighting) refers to a type of lighting that uses semiconductor light-emitting diodes (LEDs), organic light-emitting diodes (OLED), or polymer light-emitting diodes (PLED) as sources of illumination. In this group, diodes LED (Led Emitting Diode) are currently the most popular due to their advantages: small power consumption, great luminosity, short response time, small dimensions and harmlessness to the environment. | 23



Outdoor lighting perform many functions, among which the safety of roads, streets and pedestrian pathways is the most vital. It also serves as directional or decorative lighting ensuring suitable atmosphere of the surroundings, especially on the public urban areas, parks and gardens.



# oświetlenie zewnątrzne

OUTDOOR LIGHTING

Oświetlenie zewnętrzne pełni szereg istotnych funkcji, z których najistotniejszą jest zapewnienie bezpieczeństwa użytkowników poruszających się po drogach, ulicach oraz ciągach pieszych. Pełni też funkcję oświetlenia orientacyjnego lub dekoracyjnego, zapewniając równocześnie właściwe klimaty i atmosferę otoczenia, szczególnie w przestrzeniach urbanistycznych miast, w parkach i ogrodach.

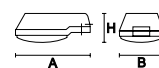
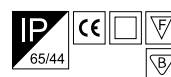

AxBxH

Klosz PC / PC diffuser, plastic housing

<b>3034000</b>	SL-100.70	HST 70W	E27	602x340x238	8,40
<b>3035000</b>	SL-100.100	HST 100W	E40	602x340x238	8,90
<b>3036000</b>	SL-100.150	HST 150W	E40	602x340x238	9,70
<b>3037000</b>	SL-100.250	HST 250W	E40	602x340x238	10,10

Oprawy z układem redukcji mocy / Luminaires with power reduction system, plastic housing

<b>3031000</b>	SL-100.100/70	HST 100W	E40	602x340x238	9,10
<b>3032000</b>	SL-100.150/100	HST 150W	E40	602x340x238	9,90
<b>3033000</b>	SL-100.250/150	HST 250W	E40	602x340x238	10,30

Oprawy z autonomicznym układem redukcji mocy / Luminaires with autonomous power reduction system, plastic housing

<b>3589000</b>	SL-100.RM 100/70	HST 100W	E40	602x340x238	9,10
<b>3588000</b>	SL-100.RM 150/100	HST 150W	E40	602x340x238	9,90
<b>3587000</b>	SL-100.RM 250/150	HST 250W	E40	602x340x238	10,30

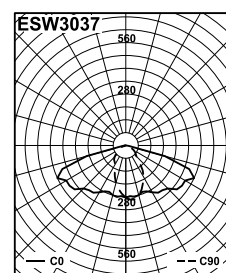
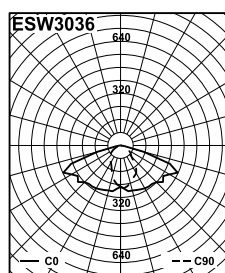

Oprawa uliczna do montażu na maszcie pionowym lub wysięgniku. LAMPY WYŁADOWCZE. Stateczniki indukcyjne z kompensacją mocy biernej. Obudowa z tworzywa poliestrowego wzmocnianego włóknem szklanym lub z odlewu aluminiowego. Dyfuzor z poliwęglanu lub szyba hartowana w ramce poliestrowej. Odbłyśnik aluminiowy. Opcjonalnie oprawa produkowana z układem redukcji mocy, także autonomicznym. Mocowanie na wysięgniku Ø 42, 48, 60 mm lub maszcie pionowym 60, 76 mm. Oświetlenie dróg głównych, dojazdowych i osiedlowych, terenów otwartych; kolejowych i przemysłowych.

Street luminaire for installation on a vertical pole or an extension arm. HID lamps. Inductive ballasts with power compensation. Available also with an autonomic power reduction system. Housing of polyester reinforced with glass fibre or cast aluminium. Diffuser of PC or hardened glass in a polyester frame. Aluminium reflector. Installation on arms Ø 42, 48, 68 mm or vertical poles Ø 60, 76 mm. Lighting for streets, squares, railways and open industrial areas.

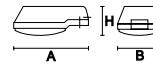

AxBxH

Klosz PC, pokrywa z aluminium / PC diffuser, aluminium housing

<b>3034200</b>	SL-100.Al.70	HST 70W	E27	602x340x238	8,40
<b>3035200</b>	SL-100.Al.100	HST 100W	E40	602x340x238	8,90
<b>3036200</b>	SL-100.Al.150	HST 150W	E40	602x340x238	9,70
<b>3037200</b>	SL-100.Al.250	HST 250W	E40	602x340x238	10,10

Oprawy z układem redukcji mocy, pokrywa z aluminium /  
Luminaires with power reduction system, aluminium housing

<b>3031210</b>	SL-100.Al.100/70	HST 100W	E40	602x340x238	9,10
<b>3032200</b>	SL-100.Al.150/100	HST 150W	E40	602x340x238	9,90
<b>3033200</b>	SL-100.Al.250/150	HST 250W	E40	602x340x238	10,30

Oprawy z autonomicznym układem redukcji mocy, pokrywa z aluminium /  
Luminaires with autonomous power reduction system, aluminium housing

<b>3589200</b>	SL-100.Al.RM 100/70	HST 100W	E40	602x340x238	9,10
<b>3588200</b>	SL-100.Al.RM 150/100	HST 150W	E40	602x340x238	9,90
<b>3587200</b>	SL-100.Al.RM 250/150	HST 250W	E40	602x340x238	10,30



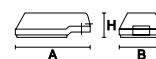
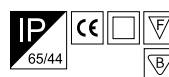

Klosz szklany / Glass shade

AxBxH

<b>3026000</b>	SL-100/PKP.125	HME 125W	E27	602x340x195	9,50
<b>3027000</b>	SL-100/PKP.70	HSE-E 70W	E27	602x340x195	9,60
<b>3028000</b>	SL-100/PKP.100	HSE 100W	E40	602x340x195	10,90
<b>3029000</b>	SL-100/PKP.150	HSE 150W	E40	602x340x195	10,90
<b>3030000</b>	SL-100/PKP.250	HSE 250W	E40	602x340x195	11,30
<b>3470000</b>	SL-100/PKP.2x150	2xHST 150W	2xE40	602x340x195	13,30

Oprawy z układem redukcji mocy / Luminaires with power reduction system

<b>3023000</b>	SL-100/PKP.100/70	HSE 100W	E40	602x340x195	9,10
<b>3024000</b>	SL-100/PKP.150/100	HSE 150W	E40	602x340x195	9,90
<b>3025000</b>	SL-100/PKP.250/150	HSE 250W	E40	602x340x195	10,30

Oprawy z autonomicznym układem redukcji mocy / Luminaires with autonomous power reduction system

<b>3592000</b>	SL-100/PKP.RM100/70	HST 100W	E40	602x340x195	9,10
<b>3591000</b>	SL-100/PKP.RM150/100	HST 150W	E40	602x340x195	9,90
<b>3590000</b>	SL-100/PKP.RM250/150	HST 250W	E40	602x340x195	10,30

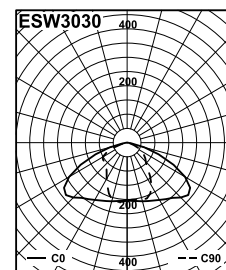
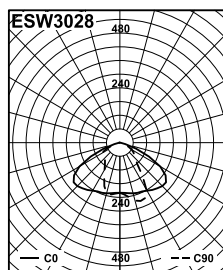

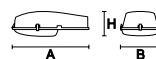
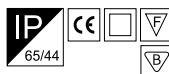

AxBxH



<b>3290000</b>	WSL-850 50W	HST 50W	E27	537x268x175	4,00
<b>3291000</b>	WSL-870 70W	HST 70W	E27	537x268x175	4,10
<b>3292000</b>	WSL-800 100W	HST 100W	E40	537x268x175	4,90
<b>3294000</b>	WSL-815 150W	HST 150W	E40	537x268x175	5,00

Oprawy z autonomicznym układem redukcji mocy / Luminaires with autonomous power reduction system

<b>3476000</b>	WSL-815.RM 150/100W	HST 150W	E40	537x268x175	5,50
<b>3477000</b>	WSL-800.RM 100/70W	HST100W	E40	537x268x175	5,30
<b>3478000</b>	WSL-870.RM 70/50W	HST 70W/E	E27	537x268x175	5,20

Oprawy z odbłyśnikiem Boyen / Luminaires with Boyen reflector

<b>3290200</b>		HST 50W	E27	537x268x175	4,00
<b>3291200</b>		HST 70W	E27	537x268x175	4,10

Oprawa z odbłyśnikiem Boyen i z autonomicznym układem redukcji mocy / Luminaire with Boyen reflector autonomous power reduction system

<b>3478200</b>		HST 70W	E27	537x268x175	5,20
----------------	--	---------	-----	-------------	------

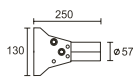

Akcesoria / Accessories

<b>9081000</b>	ŁMR	łąącznik masztu regulowany / adjustable mast joiner
<b>9082000</b>	WNNR	wysięgnik naścienny-narożny regulowany / adjustable arm
<b>9493000</b>	ŁMR.SL	łąącznik masztu regulowany / adjustable mast joiner

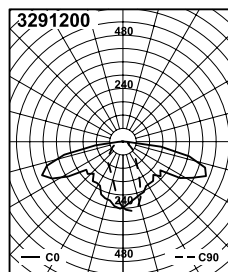
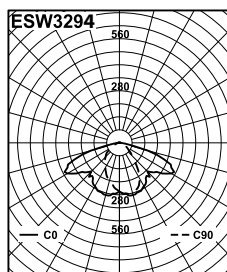

Oprawa uliczna do montażu na wysięgniku. Lamy wyładowcze. Stateczniki indukcyjne z kompensacją mocy bierniej. Obudowa z tworzywa poliestrowego wzmacnianego włóknem szklanym. Dyfuzor z przezroczystego poliwęglanu odpornego na promieniowanie UV. Odbłyśnik aluminiowy. Opcjonalnie oprawa z autonomicznym układem redukcji mocy. Regulacja kąta pochylenia za pomocą dodatkowych akcesoriów. Oświetlenie terenów otwartych, dróg osiedlowych, ciągów pieszych, parków, placów.

Street luminaire for installation on an extension arm. HID lamps. Inductive ballasts with power compensation. Available also with an autonomic power reduction system. Housing of polyester reinforced with glass fibre. Diffuser of transparent, UV-protected PC. Aluminium reflector. Additional accessories to adjust the tilt. Lighting for side streets, pedestrian paths, squares.

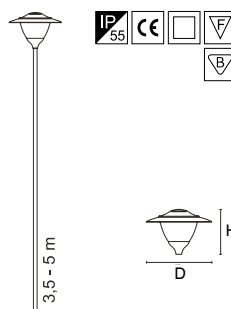

Klosz: poliamid (PA) opalowy / Shade: opal polyamide (PA)

<b>3098000</b>	OCP-70-PA/II	HSE-E 70W/HST 70W	E27	650x450	4,40
<b>3518000</b>	OCP-100-PA/II	HST 100W	E40	650x450	4,40
<b>3099000</b>	OCP-125-PA/II	HME 125W	E27	650x450	4,30
<b>3100000</b>	OCP-160-PA/II	A60 150W/HMR-SB 160W/TC-TSE 23W	E27	650x450	3,10

Klosz: poliwęglan (PC) opalowy / Shade: opal polycarbonate (PC)

<b>3102000</b>	OCP-70-PC/II	HSE-E 70W/HST 70W	E27	650x450	4,40
<b>3504000</b>	OCP-100-PC/II	HST 100W	E40	650x450	4,40
<b>3103000</b>	OCP-125-PC/II	HME 125WA60 150W/	E27	650x450	4,30
<b>3104000</b>	OCP-160-PC/II	HMR-SB 160W/TC-TSE 23W	E27	650x450	3,10
<b>3324200</b>	OCP-150 PC/II	HIT 150W	E40	650x450	4,90

IA<sup>25°</sup> = 224/1000 lm  
LA<sup>25°</sup> = 443/1000 lm

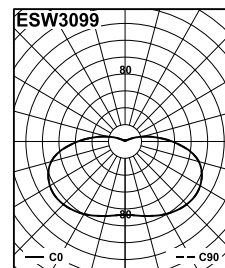

Dekoracyjna oprawa parkowa do montażu na maszcie pionowym lub wysięgniku. Światłówki zintegrowane, lampy wyładowcze lub rtęciowo-żarowe. Korpus z odlewu aluminiowego. Dyfuzor z tworzywa sztucznego. Raster przeciwodbleniowy aluminiowy. Osprzęt elektryczny umieszczony wewnątrz korpusu. Oświetlenie terenów otwartych, dróg osiedlowych, ciągów pieszych, parków, placów.

Outdoor luminaire for installation on a vertical pole or an extension arm. Compact fluorescent, HID or mercury lamps. Gearbox of cast aluminium. Integral gears. Plastic diffuser. Aluminium antiglare louvre. For amenity lighting, side streets, pedestrian paths, squares, parks and gardens.

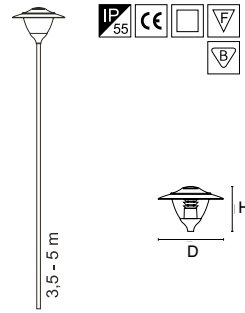

DxH

Klosz: poliwęglan (PC) przezroczysty / Shade: transparent polycarbonate (PC)

<b>3130000</b>	OCP-70B-PC/II	HSE-E 70W/HST 70W	E27	650x450	4,60
<b>3505000</b>	OCP-100B-PC/II	HST 100W	E40	650x450	4,40
<b>3131000</b>	OCP-125B-PC/II	HME 125	E27	650x450	4,50
<b>3132000</b>	OCP-160B-PC/II	A60 150W/HMR-SB 160W/TC-TSE 23W	E27	650x450	3,30
<b>3324000</b>	OCP-150B-PC/II	HIT150W	E40	650x450	5,10

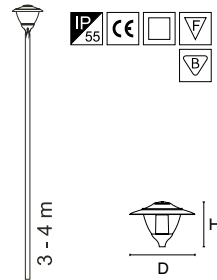

DxH

Klosz: poliwęglan (PC) ryflowany / Shade: ribbed polycarbonate (PC)

<b>3133000</b>	OCP-70R-PC/II	HSE-E 70W/HST 70W	E27	650x450	4,40
<b>3506000</b>	OCP-100R-PC/II	HST 100W	E40	650x450	4,40
<b>3134000</b>	OCP-125R-PC/II	HME 125W	E27	650x450	4,30
<b>3135000</b>	OCP-160R-PC/II	A60 150W/HMR-SB 160W/TC-TSE 23W	E27	650x450	3,10
<b>3324100</b>	OCP-150 R-PC/II	HIT 150W	E40	650x450	4,90

IA<sup>0.5</sup> = 188/1000 lm  
LA<sup>0.25</sup> = 494/1000 lm

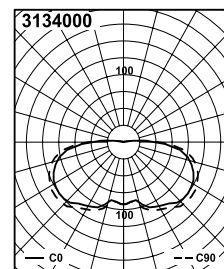

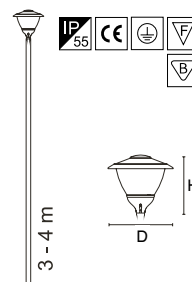

Klosz: poliamid (PA) opalowy / Shade: opal polyamide (PA)

<b>3242000</b>	OCP-70-PA	HSE-E 70W/HST 70W	E27	520x450	4,40
<b>3245000</b>	OCP-125-PA	HME 125W	E27	520x450	4,40
<b>3246000</b>	OCP-160-PA	A60 150W/HMR-SB 160W/TC-TSE 23W	E27	520x450	4,30

Klosz: poliwęglan (PC) opalowy / Shade: opal polycarbonate (PC)

<b>3243000</b>	OCP-70-PC	HSE-E 70W/HST 70W	E27	520x450	4,30
<b>3244000</b>	OCP-125-PC	HME 125W	E27	520x450	3,10
<b>3247000</b>	OCP-160-PC	A60 150W/HMR-SB 160W/TC-TSE 23W	E27	520x450	3,10

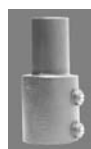
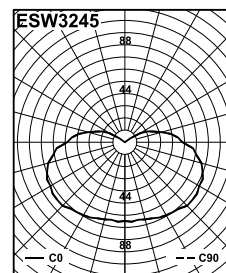

Aksesoria / Accessories

<b>9080000</b>	R60/48	reduktor średnicy masztu Ø 60/48 (stosować tylko do opraw z kloszem do góry) pole top reduction Ø 60/48 (only for vertical poles and upright position)
----------------	--------	---



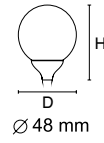

DxH

Klosz: akrylik (PMMA) opalowy / Shade: opal acrylic (PMMA)

<b>3106000</b>	OCP-70.K-PM/II	HSE-E 70W/HST 70W	E27	400x505	4,60
<b>3519000</b>	OCP-100.K-PM/II	HST 100W	E40	400x505	4,60
<b>3107000</b>	OCP-125.K-PM/II	HME 125W	E27	400x505	4,50
<b>3108000</b>	OCP-160.K-PM/II	A60 150W/HMR-SB 160W/TC-TSE 23W	E27	400x505	3,30

Klosz: poliwęglan (PC) opalowy / Shade: opal polycarbonate (PC)

<b>3110000</b>	OCP-70.K-PC/II	HSE-E 70W/HST 70W	E27	400x505	4,60
<b>3509000</b>	OCP-100.K-PC/II	HST 100W	E40	400x505	4,60
<b>3111000</b>	OCP-125.K-PC/II	HME 125W	E27	400x505	4,50
<b>3112000</b>	OCP-160.K-PC/II	A60 150W/HMR-SB 160W/TC-TSE 23W	E27	400x505	3,30

IA<sup>0,5</sup> = 183/1000 lm  
LA<sup>0,25</sup> = 308/1000 lm

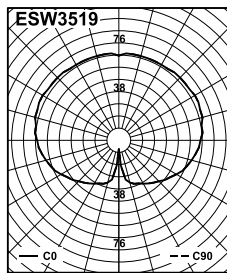

IA<sup>0,5</sup> = 183/1000 lm  
LA<sup>0,25</sup> = 308/1000 lm

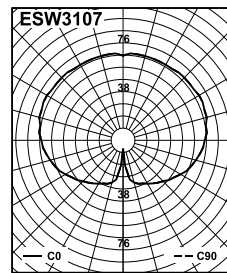

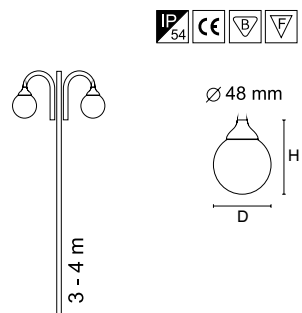

Klosz: akrylik (PMMA) opalowy / Shade: opal acrylic (PMMA)

□	<b>3264000</b>	OCP-70.KD-PM/II	HSE-E 70W/HST 70W	E27	400x505	4,60
⊕	<b>3319000</b>	OCP-125.KD-PM/I	HME 125W	E27	400x505	4,50
□	<b>3265000</b>	OCP-160.KD-PM/II	A60 150W/HMR-SB 160W/TC-TSE 23W	E27	400x505	3,30

Klosz: poliwęglan (PC) opalowy / Shade: opal polycarbonate (PC)

⊕	<b>3510000</b>	OCP-100.KD-PC	HST 100W	E40	400x505	4,50
⊕	<b>3258000</b>	OCP-125.KD-PC	HME 125W	E27	400x505	4,50
□	<b>3118000</b>	OCP-70.KD-PC/II	HSE-E 70W/HST 70W	E27	400x505	4,60
□	<b>3120000</b>	OCP-160.KD-PC/II	A60 150W/HMR-SB160W/TC-TSE 23W	E27	400x505	3,30

IA<sup>0,5</sup> = 183/1000 lm  
LA<sup>0,25</sup> = 308/1000 lm

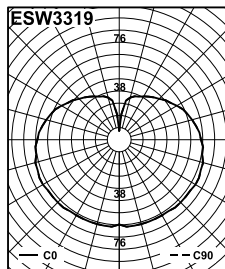

IA<sup>0,5</sup> = 183/1000 lm  
LA<sup>0,25</sup> = 308/1000 lm

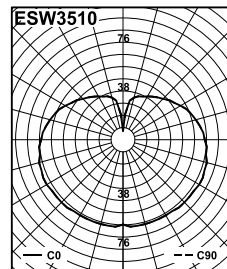

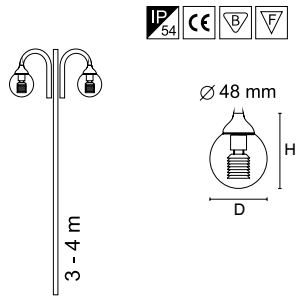

DxH

Klosz: akrylik (PMMA) / Shade: acrylic (PMMA)

<input type="checkbox"/>	<b>3266000</b>	OCP-70.KPD-PM/II	HSE-E 70W/HST 70W	E27	400x505	4,20
--------------------------	----------------	------------------	-------------------	-----	---------	------

Klosz: poliwęglan (PC) / Shade: polycarbonate (PC)

<input type="checkbox"/>	<b>3126000</b>	OCP-70.KPD-PC/II	HSE-E 70W/HST 70W	E27	400x505	5,10
<input checked="" type="checkbox"/>	<b>3328000</b>	OCP-150.KPD-PC	HST 150W	E27	600x730	7,10
<input checked="" type="checkbox"/>	<b>3346000</b>	OCP-150.KBD-PC	HST 150W	E40	600x730	7,10

IA<sup>0.5</sup> = 163/1000 lm  
LA<sup>0.25</sup> = 398/1000 lm

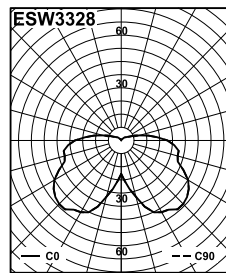
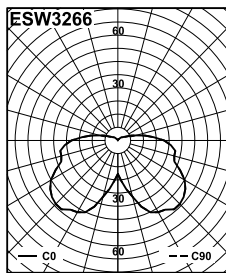

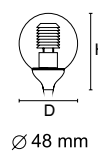
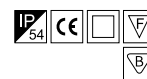
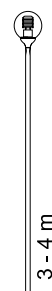

Klosz: akrylik (PMMA) / Shade: acrylic (PMMA)

<b>3261000</b>	OCP-70.KP-PM/II	HSE-E 70W/HST 70W	E27	400x505	4,60
<b>3520000</b>	OCP-100.KP-PM/II	HST 100W	E40	400x505	4,60
<b>3262000</b>	OCP-125.KP-PM/II	HME 125W	E27	400x505	4,70
<b>3263000</b>	OCP-160.KP-PM/II	A60 150W/HMR-SB 160W/TC-TSE 23W	E27	400x505	4,80

Klosz: poliwęglan (PC) / Shade: polycarbonate (PC)

<b>3122000</b>	OCP-70.KP-PC/II	HSE-E 70W/HST 70W	E27	400x505	5,10
<b>3512000</b>	OCP-100.KP-PC/II	HST 100W	E40	400x505	5,10
<b>3341000</b>	OCP-150.KB-PC	HST 150W	E40	400x505	7,10
<b>3123000</b>	OCP-125.KP-PC/II	HME 125W	E27	400x505	5,00
<b>3124000</b>	OCP-160.KP-PC/II	A60 150W/HMR-SB 160W/TC-TSE 23W	E27	400x505	3,80
<b>3325000</b>	OCP-150.KP-PC	HST 150W	E40	400x505	7,10

IA<sup>0.5</sup> = 221/1000 lm  
LA<sup>0.5</sup> = 563/1000 lm

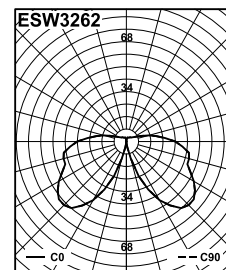
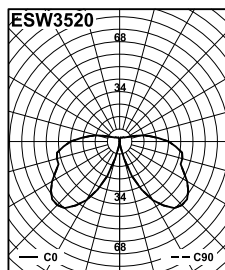

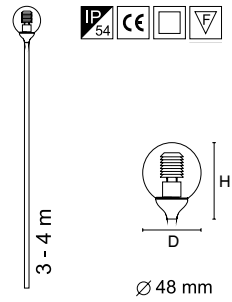

DxH

Klosz: akrylik (PMMA) / Shade: acrylic (PMMA)

<b>4787000</b>	OCP-QL85	QL 85W	E27	400x505	4,20
<b>7800000</b>	OCP-QL55	QL 55W	E27	400x505	4,10

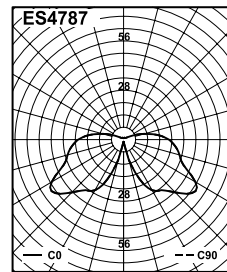



AxBxCxD

Wersja z zasilaczem zainstalowanym we wnęce słupowej /  
Version with controlgear installed inside the pole's recess

<b>3404009</b>	AL250	HIT-DE 250W	Fc2	1400x900x1200x530	54,00
----------------	-------	-------------	-----	-------------------	-------

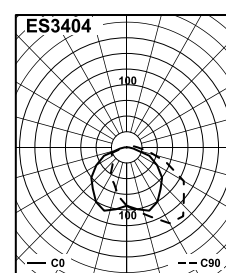

Zestaw oświetlenia pośredniego: naświetlacz i odbłyśnik do montażu na słupie. Lamy wyładowcze. Zasilacz indukcyjny do zainstalowania we wnętrzu słuza. Słup stalowy. Obudowa oprawy z odlewu aluminiowego. Szyba ochronna hartowana. Odbłyśnik ze specjalnego tworzywa o wysokiej wytrzymałości i wysokim współczynnikiem odbicia światła. Słupy zamawiane oddzielnie, przystosowane do fundamentu F150. System oświetlenia pośredniego reprezentacyjnych przestrzeni urbanistycznych, placów i ulic.

Indirect lighting system consisting of pole-mounted projector and reflector. HID lamps. Inductive power supply installed in pole's recess. Housing of cast aluminium. Hardened protective glass. Reflector of specialist, durable plastic with high reflection factor. Steel poles, screwed on pre-cast foundation to be ordered separately. Recommended for representative urban areas, squares, avenues, etc.

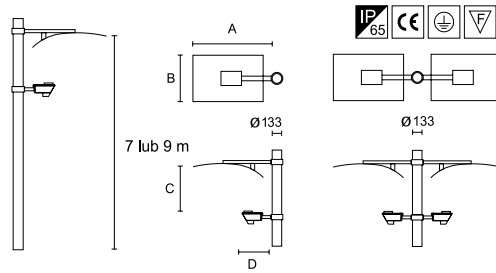

AxBxCxD



Wersja z zasilaczem zainstalowanym we wnęcie słupowej /  
Version with controlgear installed inside the pole's recess

**3412009** AL250.2 2xHIT-DE 250W Fc2 1400x900x1200x530 100,00

Układ zasilający do montażu we wnęcie słupa dostarczany w komplecie z oprawą /  
Controlgear for installation in the pole's recess supplied with the luminaire



AxBxC

**9435000** PZ 250W 74x355x60

#### UWAGA!

Uchwyty odbłyśnika i naświetlacza dla standardowej średnicy słupa Ø 130–133 mm.

NOTE:

Standard reflector/projector clamps are fitted for pole's tops Ø 130–133 mm.

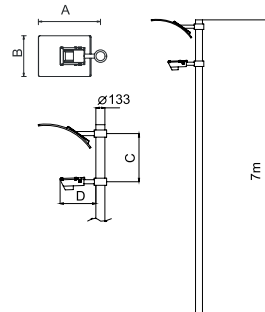

AxBxCxD



Wersja mini / Version mini

**3407109** AL 150 HIT-CRI 150W G12 915x600x710x530 50,00



Wersja mini / Version mini

**3407209** AL 150.2 2xHIT-CRI 150W G12 915x600x710x530 100,00

## słupy / poles

Słupy SYSTEMU ALBATROS są przewidziane do fundamentów typu F150 produkcji Elektromontaż Rzeszów S.A. lub równoważnych. Kolor: RAL 7042 struktura.

Poles of SYSTEM ALBATROS for precast foundation type F150 made by Elektromontaż Rzeszów S.A. or equivalent. Finish: RAL 7042 textured.

**P1** – jeden przepust na naświetlacz  
P1 – single projector's holder

**P2** – dwa przepusty na naświetlacze (180°)  
P2 – twin projector's holder (180°)

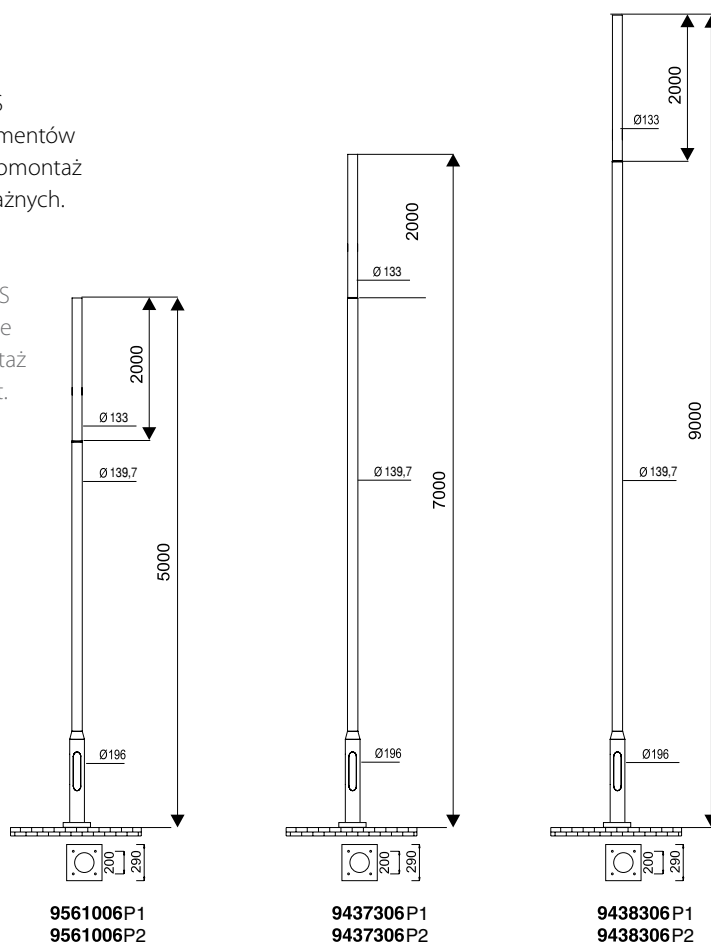

słupy stalowe / steel poles

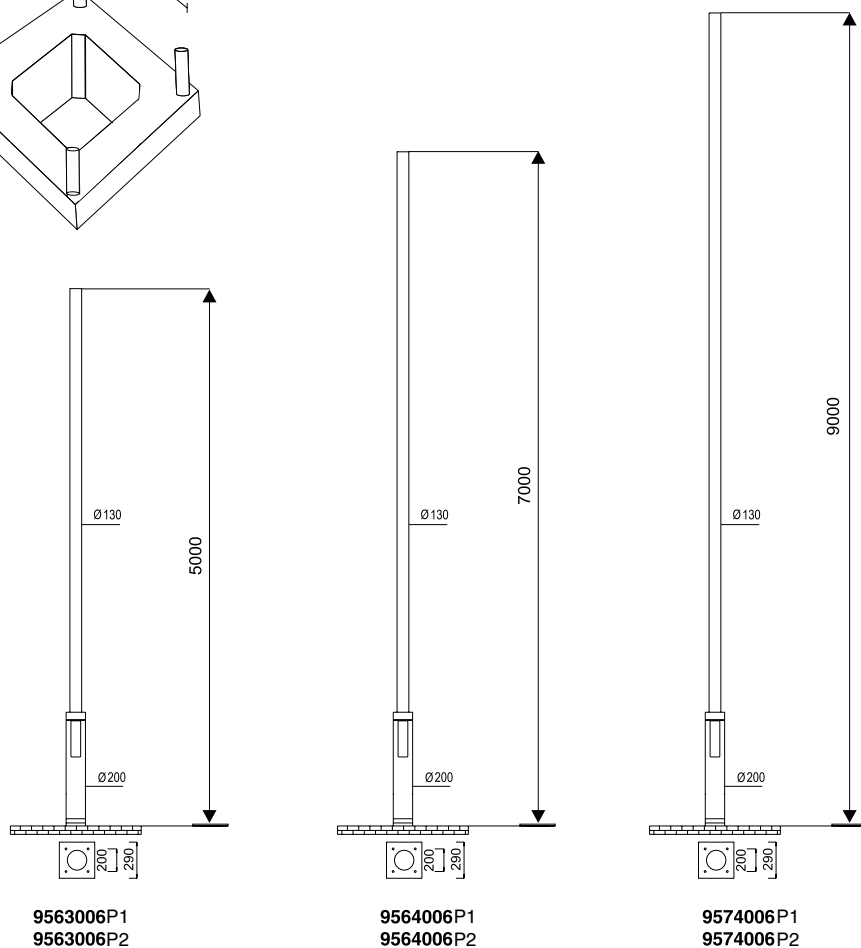
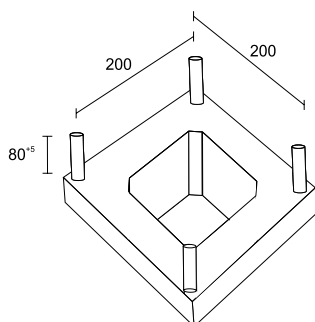

słupy aluminiowe / aluminium poles

# INDEX

---

3023000	28	3050520M	12	3055120M	8	3110000	33	3478200	29
3024000	28	3050550	16	3055200	10	3111000	33	3504000	30
3025000	28	3051000	14	3055200M	10	3112000	33	3506000	31
3026000	28	3051100	14	3055220	8	3118000	34	3509000	33
3027000	28	3051120	12	3055220M	8	3120000	34	3510000	34
3028000	28	3051200	14	3055300	10	3122000	36	3512000	36
3029000	28	3051220	12	3055300M	10	3123000	36	3518000	30
3030000	28	3051300	14	3055320	8	3124000	36	3519000	33
3031000	26	3051320	12	3055320M	8	3126000	35	3520000	36
3031210	27	3051350	16	3055400	10	3133000	31	3587000	26
3032000	26	3051400	14	3055400M	10	3134000	31	3587200	27
3032200	27	3051410	18	3055420	8	3135000	31	3588000	26
3033000	26	3051420	12	3055420M	8	3242000	32	3588200	27
3033200	27	3051450	16	3055500	10	3243000	32	3589000	26
3034000	26	3051500	14	3055500M	10	3244000	32	3589200	27
3034200	27	3051520	12	3055520	8	3245000	32	3590000	28
3035000	26	3052000	14	3055520M	8	3246000	32	3591000	28
3035200	27	3052020	12	3056000	10	3247000	32	3592000	28
3036000	26	3052040	18	3056100	10	3258000	34	4787000	37
3036200	27	3052050	16	3056120	8	3261000	36	5003070	22
3037000	26	3052100	14	3056200	10	3262000	36	5003100	22
3037200	27	3052120	12	3056220	8	3263000	36	7800000	37
3050000	14	3052140	18	3056300	10	3264000	34	9080000	32
3050000M	14	3052150	16	3056320	8	3265000	34	9081000	29
3050100	14	3052200	14	3056400	10	3266000	35	9082000	29
3050100M	14	3052220	12	3056420	8	3290000	29	9435000	39
3050120	12	3052240	18	3056500	10	3290200	29	9437306P1	40
3050120M	12	3052250	16	3056520	8	3291000	29	9437306P2	40
3050200	14	3053020	12	3057000	10	3291200	29	9438306P1	40
3050200M	14	3053030	14	3057100	10	3292000	29	9438306P2	40
3050220	12	3053040	18	3057200	10	3294000	29	9493000	29
3050220M	12	3053050	16	3058000	10	3319000	34	9561006P1	40
3050300	14	3053120	12	3058020	8	3324100	31	9561006P2	40
3050300M	14	3053130	14	3058100	10	3324200	30	9563006P1	40
3050320	12	3053140	18	3058120	8	3325000	36	9563006P2	40
3050320M	12	3053150	16	3058200	10	3328000	35	9564006P1	40
3050350	16	3053220	12	3058220	8	3341000	36	9564006P2	40
3050400	14	3053230	14	3098000	30	3346000	35	9574006P1	40
3050400M	14	3053240	18	3099000	30	3404009	38	9574006P2	40
3050410	18	3053250	16	3100000	30	3407109	39		
3050410M	18	3054030	20	3102000	30	3407209	39		
3050420	12	3055000	10	3103000	30	3412009	39		
3050420M	12	3055000M	10	3104000	30	3470000	28		
3050500	14	3055100	10	3106000	33	3476000	29		
3050500M	14	3055100M	10	3107000	33	3477000	29		
3050520	12	3055120	8	3108000	33	3478000	29		

Uw dealer:



4e Industriestraat 33  
3133 EK Vlaardingen  
Postbus 35106  
3005 DC Rotterdam

T +31 (0)10 434 73 48  
E info@solumo.nl  
W www.solumo.nl

**ODDZIAŁ MAZURY**

WILKASY, ul. Olsztyńska 2  
11-500 Giżycko  
tel. 87 429 96 30 - 38, fax 87 429 96 02  
mazury@essystem.pl

**ODDZIAŁ GDAŃSK**

80-435 GDAŃSK, ul. Biała 1  
tel. 58 345 23 45, fax 58 341 91 11  
gdansk@essystem.pl

**ODDZIAŁ ŁÓDŹ**

91-072 ŁÓDŹ, ul. Legionów 93/95  
tel. 42 633 60 13, fax 42 633 58 67  
lodz@essystem.pl

**ODDZIAŁ POZNAŃ**

61-894 POZNAŃ, ul. Niezłomnych 1a  
tel. 61 851 80 89, fax 61 851 76 80  
poznan@essystem.pl

**ODDZIAŁ RZESZÓW**

35-322 RZESZÓW, ul. Spichlerzowa 42  
tel. 17 850 82 30, fax 17 850 82 85  
rzeszow@essystem.pl

**ODDZIAŁ ŚLĄSK**

44-100 GLIWICE, ul. Wincentego Pola 16  
tel. 32 339 31 56, fax 32 339 31 55  
slask@essystem.pl

**ODDZIAŁ WARSZAWA**

03-301 WARSZAWA, ul. Jagiellońska 78  
tel. 22 334 63 30 do 35, fax 22 334 63 36  
warszawa@essystem.pl

**ODDZIAŁ WROCŁAW**

52-315 WROCŁAW, ul. Kobierzycka 18  
tel. 71 782 82 98, fax 71 783 29 23  
wroclaw@essystem.pl

**ES-SYSTEM S.A. - CENTRALA**

30-701 KRAKÓW, ul. Przemysłowa 2  
tel. +48 12 656 36 33, fax +48 12 656 36 49  
krakow@essystem.pl